

TECHNICAL SPECIFICATIONS	ELR-30-M	ELR-30-A		
Earth Leakage Relay	Type A			
SUPPLY				
Supply Voltage	220-415VAC / 220VDC -20% to +20%			
Power Consumption (Max.)	10VA			
LED Indication	Power On	ON (Green Led)		
	EL / CT	ON (Red Led) Relay Trip / Blinking (CT OPEN)		
	Leakage Current/ TST	BY bar graph 30%(Green), 45%(Green), 60%(Yellow), and 75%(Red), Blink Test/Reset Switch is pressed		
Threshold I Δ n (A)	0.03 – 0.1 – 0.3 – 0.5 – 1 – 3 – 5 – 10 – 20 – 30			
Frequency	50-60Hz			
RELAY O / P				
Contact Rating	1 C/O + 1 NO; 5 A (Resistive) @ 240 VAC / 30 VDC			
Contact Arrangement	1 C/O SPDT and 1 NO SPST			
Utilization Category (AC-15)	3.0 A at 120 V & 1.5 A at 240 V			
Utilization Category (DC-13)	0.22 A at 125 V & 0.10 A at 250 V			
Mechanical Life Expectancy	1X10 ⁷			
Electrical Life Expectancy	1X10 ⁵			
Contact Material	Ag Alloy			
RESET				
Reset	Manual Reset	Auto Reset		
No. Of Auto Resets	-	4		
Clear Auto Reset	After 1 hour of healthy condition or supply interruption			
Test / Reset	Local and Remote (Non Potential Free Contacts) (Up to 10 m)			
Δ t Settings (s)	0.040 – 0.06 – 0.15 – 0.25 – 0.5 – 0.8 – 1 – 2.5 – 5 – 10			
Reset Enable	Below 50% of set I Δ n in presence of CBCT			
Reset Time	<1 s			
Type Class	'A' True RMS measurement upto I Δ 1A (as per IEC 60947-2 Annex M)			
Setting Accuracy	'AC' True RMS measurement 30mA to 30A (as per IEC 60947-2 Annex M)			
Repeat Accuracy	- 20% (Including CBCT accuracy)			
AMBIENT				
Storage Temperature	\pm 2%			
Operating Temperature	-20°C to + 80°C			
Relative Humidity	-15°C to + 60°C			
Max. Operating Altitude	5 to 95% Rh (without condensation)			
Degree of Protection	2000 m			
Operating Position	IP-20 for Terminals, IP-40 for Enclosure			
Pollution Degree	Any			
OTHERS				
Mounting	Din Rail			
Dimensions in mm (W X H X D)	36 X 90 X 65			
Weight Approx. (Un-packed)	150g			
Certification				
CBCT for Type A & AC Current				
	Size (W X H X D) mm	Inner Diameter	Max. Current Per Phase	I Δ n setting range if there are pulsating DC current(Type A)
CBCT-70	37x133x109.3	70mm	160A	30mA to 3A
CBCT-92	37x155x132	92mm	200A	30mA to 3A
CBCT-120	37x176x153	120mm	250A	30mA to 3A
CBCT-210	37x282x250	210mm	400A	30mA to 3A
CBCT-R-350 DİKDÖRTGEN AKIM TRAFOSU				
Turns Ratio	1 : 1500			
Rated Frequency	50-60Hz			
Leakage Current Range	30mA... 30A			
Rated Operational Current	Up to 2500A			
Operating Temperature	-20°C...+65°C			
Storage Temperature	-20°C...+85°C			
Dimension(mm)	350 x 150x 30mm			
Weight(Kg)	3.7Kg			

ELR & CBCT EARTH LEAKAGE RELAY & CORE BALANCE CURRENT TRANSFORMERS SERIES

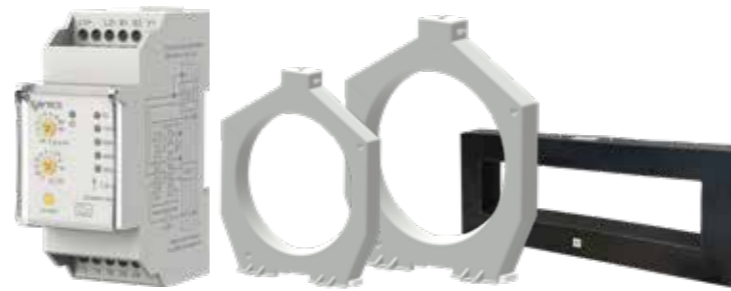

ENTES Quick Start Manual

Trip Characteristics

Standard IEC 60947-2 annex M indicates the operating characteristic for a non-time-delay type in table B.1 in B.4.2.4.1 in standard IEC 60947-2 annex M. CBRs having I Δ n = 30 mA shall be of the non-time-delay type. If the trip time is set at '0' sec, then for 5 I Δ n & 10 I Δ n, the tripping time will be < 40 ms for all current ranges.

Earth Leakage Current	I Δ n	2I Δ n	5I Δ n ¹	10I Δ n ²
Maximum Break Time	0.3	0.15	0.04	0.04
1) For CBRs having I Δ n < 30 mA, 0.25 A may be used as an alternative to 5I Δ n				
2) 0.5 A if 0.25 A is used				



For CBR's having limiting non-actuating time of 0,06 s the operating characteristic is given in table B.2. in B.4.2.4.1 in standard IEC 60947-2 annex M.

Earth Leakage Current	I Δ n	2I Δ n	5I Δ n ¹	10I Δ n ²
Maximum Break Time	0.5	0.2	0.15	0.15

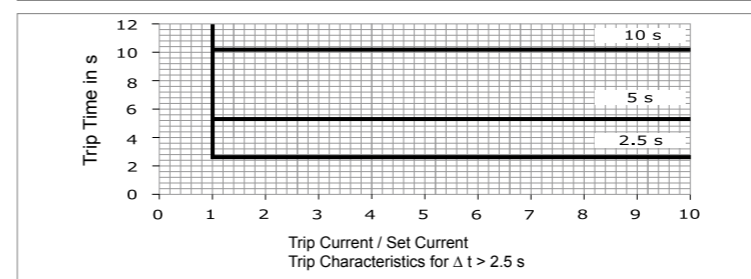
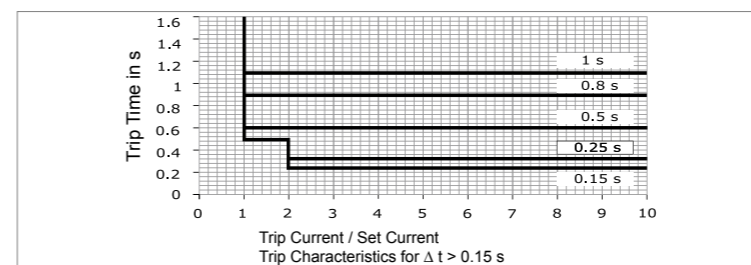
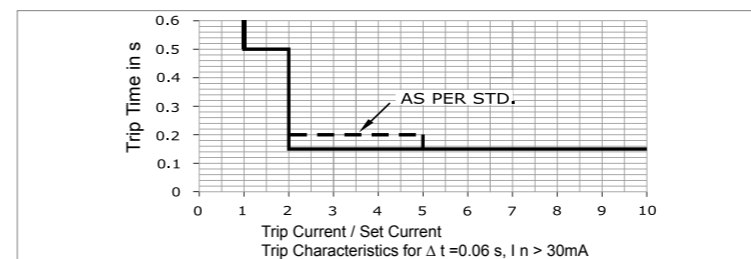

Trip Characteristics for t ≥ 0.15s

EN 60947-2:2003
B.4.2.4.2.2 Operating characteristic for CBR's having a limiting non-actuating time higher than 0.06 s declared by ENTES. The maximum break time at I Δ n, 2 I Δ n, 5 I Δ n, and 10 I Δ n.

Earth Leakage Current Trip setting	Maximum Break Time			
	I Δ n	2I Δ n	5I Δ n ¹	10I Δ n ²
0.15 s	0.5	0.25	0.25	0.25
0.25 s	0.5	0.35	0.35	0.35
0.5 s	0.6	0.6	0.6	0.6
0.8 s	0.9	0.9	0.9	0.9
1 s	1.1	1.1	1.1	1.1
2.5 s	2.6	2.6	2.6	2.6
5 s	5.1	5.1	5.1	5.1
10 s	10.1	10.1	10.1	10.1

Features

- Wide leakage current adjustment range
- Adjustable earth leakage trip time
- Instantaneous trip (for details refer trip characteristics)
- "Test Feature" to check product functionality
- "Manual Reset Feature" with reset button
- Remote resetting
- 1C/O+1NO relay output.
- LED indications for all failures
- Wide auxiliary supply voltage range
- DIN rail mounting
- Easy to install
- Compact size



Recommendations

It is recommended to use CBCT's as mentioned in the table, to ensure the trip current accuracy.

Caution

- Always follow instructions stated in this quick start manual.
- Before installation, ensure that specifications compatible with intended application.
- Installation must be done by a successful electrician.
- Suitable dampers must be provided in case of over-vibration during installation.
- Automation and control devices must be installed so that they are protected against any risk of involuntary actuation.
- Disconnect the power before working on the device.

Terminal Details

	0.54 N.m (4.7Lb.in) Terminal screw - M2.6
	1 x 0.2...3.3 mm ² Solid Wire
AWG	1 x 24 to 12

Use Cu Wire of 60/75°C only

Notes

- Since the innovation of the product is a regular process, we reserve the right to change all its features without prior notice.
- The factory settings of the device are set to 30mA trip and instantaneous delay. These settings can be adjusted as needed by the installation. A seal is supplied allowing the user to secure the clear window and hence prevent any unnecessary adjustment of the settings.
- To comply with regulations, it is recommended that the device should be tested periodically to ensure correct operation.
- In case of excess harmonics power transmission cables have more leakage because of low impedance offered by cable capacitance, I Δ n setting need to keep at higher level.

Functional Description Earth Leakage Protection

- Leakage current is detected through core balance current transformer.
- When earth leakage current exceeds the set value of trip current, for the trip time which is adjustable with the trimpots on the front panel, trip occurs.
- For details refer trip characteristics.
- The Red LED "EL" indicates the presence of Earth Leakage.

CBCT Connections

All main primary conductors shall pass through the core area of CBCT. Use shielded wires for secondary terminal connections to B1 & B2. Connect the shield to the Y2 terminal of device, which is circuit ground of the device. The CT wires should be placed adequately away from high current carrying conductors or source of strong magnetic field to avoid noise pickup. The Earth Leakage Relay also verifies CT connection. If CT winding is open, red LED "EL" blinks.

Functional Diagram

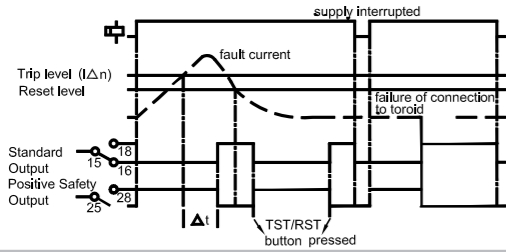

Test / Reset

Press & hold "tst/rst switch" for 1sec. The product will change its state from "healthy" to "Trip (Test)" and vice versa "Reset".

Remote Test / Reset

For "remote testing & resetting", connect an external push button/switch between Y1 and Y2. For test sequence, press and hold the external push button switch for 1sec.

Auto/ Reset

For the ELR-30-A, product will automatically reset itself after 4 earth leakage fault in 15min. Reset count is cleared after 1 hour of healthy condition, supply interruption or pressing of the test /reset switch.

Overall Dimensions and Mounting Details

ELR

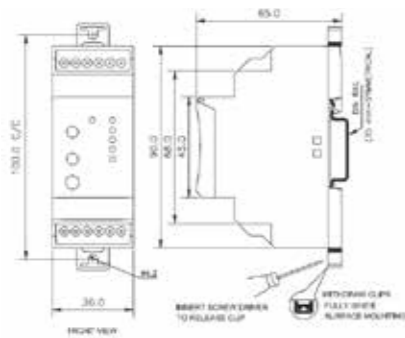

CBCT

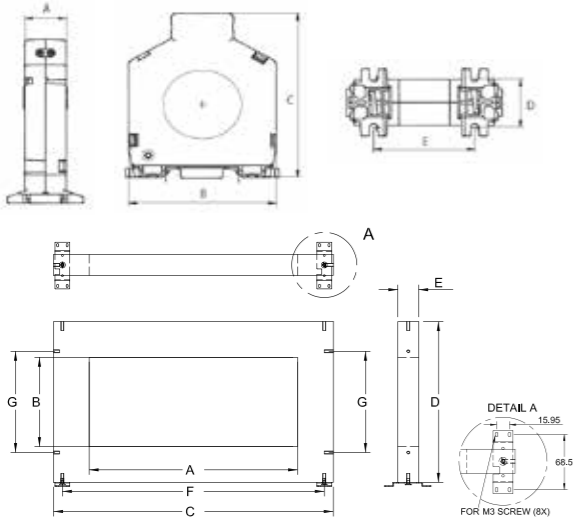

Front Face

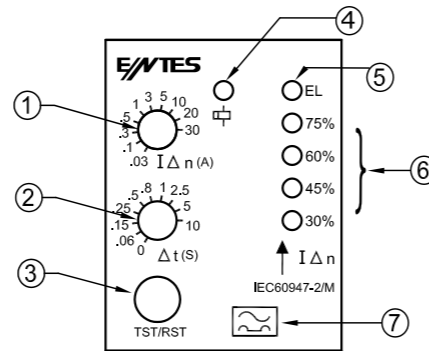

- Trimpot for "earth leakage current" setting
- Trimpot for "trip time" setting
- "Test/ Reset Function" button
- "Power ON" LED indication
- "Earth leakage fault" or "CT open" LED indication
- Bar graph for "earth leakage fault" indication
- "Type A" symbol

Notes

- For CT connections use shielded wire and connect shield to Y2 terminal.
- For single phase applications, only phase and neutral cables need to be passed through CBCT.
- Do not pass ground conductor through CBCT connected to earth leakage relay.
- All conductors to be protected must pass through CBCT.
- Do not apply supply voltage at CT and switch terminal.
- Connect the wires between CBCT and ELR with respect to B1 & B2. Wire gauge should be as mentioned under "Terminal Details".
- This device satisfies the requirements for Type A devices which provides protection against leakage current in systems alternating and

ELR Operating condition	Contact Position	
	1 NO (PSO/Fail Safe)	1 CO (PSO/Fail Safe)
No Auxiliary		
Healthy / Rest State		
Trip State		

Centre the cables within the toroid

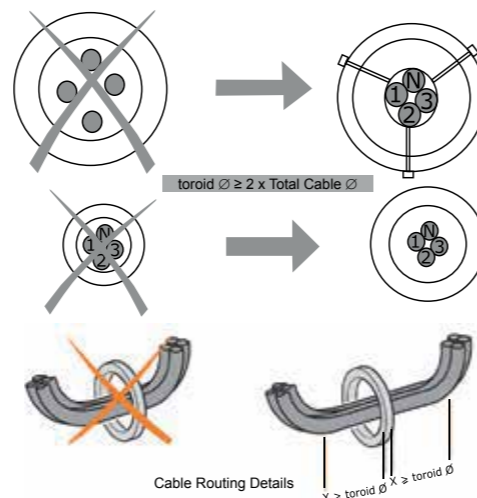

CBCT	SIZE	WEIGHT (in gr.)	A	B	C	D	E
CBCT-70	70	240	20	109	133	27	60
CBCT-92	92	250	20	132	155	27	73
CBCT-120	120	255	20	153	176	27	73
CBCT-210	210	280	20.5	250	282	28	128

Connection Diagram

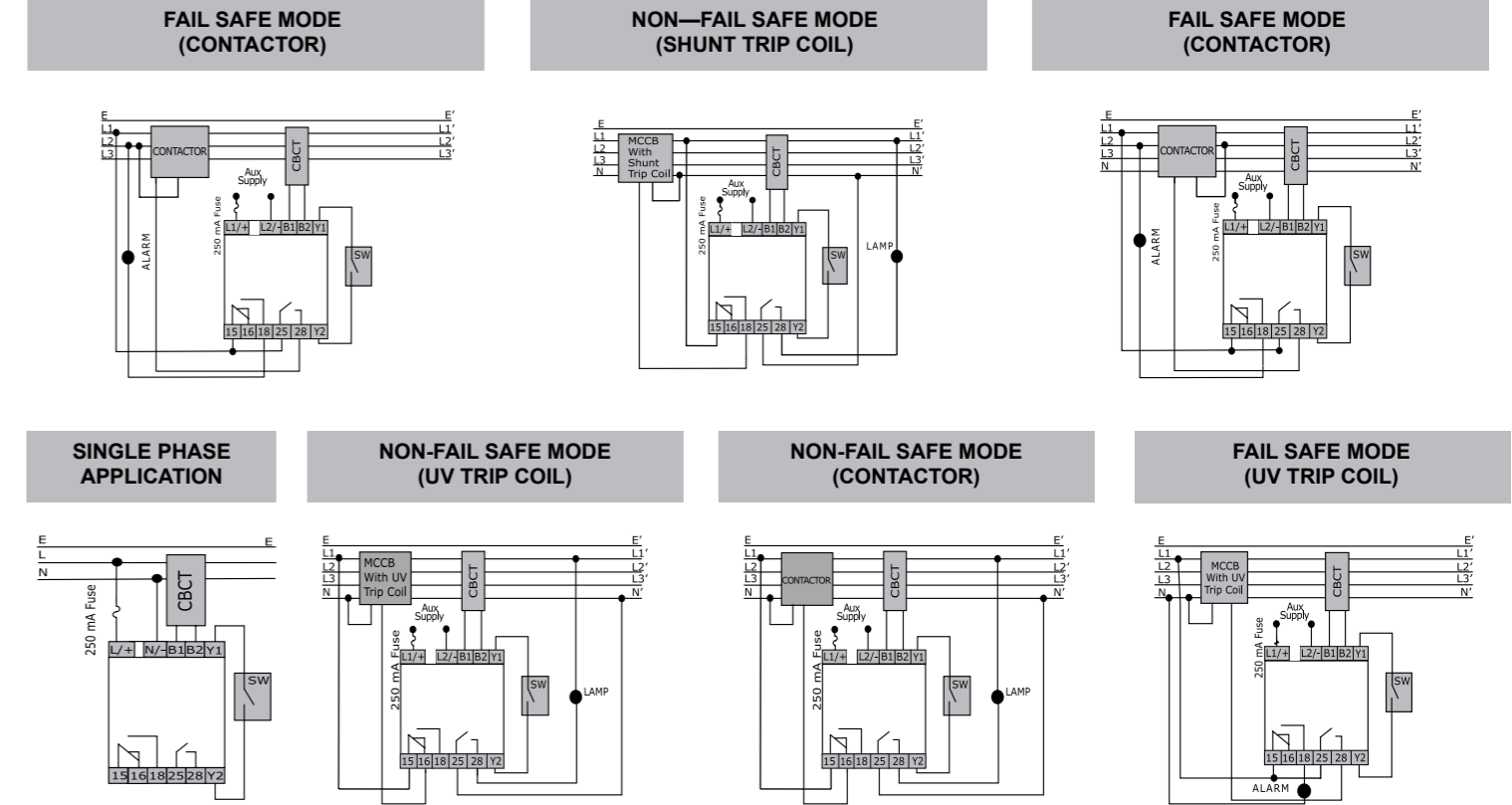

direct current are used together.

Conformity to Standards EMC

Harmonic Current Emission	IEC 61000-3-2	Class A
Voltage Flicker and Fluctuations	IEC 61000-3-3	Class A
ESD	IEC 61000-4-2	Level II
Radiated Susceptibility	IEC 61000-4-3	Level III "Criteria B"
Electrical Fast Transients	IEC 61000-4-4	Level IV
Surge	IEC 61000-4-5	Level IV for AC & Level I for DC Products
Conducted Susceptibility	IEC 61000-4-6	Level III for AC
Voltage Dips and Interruptions (AC)	IEC 61000-4-11	Level I, II, III, IV, V, VI & VIII
Voltage Dips and Interruptions (DC)	50% for 50mSec @ Nominal Voltage 15V DC	
Conducted Emission	CISPR 11	Class A
Raiated Emission	CISPR 11	Class A

Security

Test Voltage Between I /P & O/P	IEC 60947-5-1 / UL 508	2 kV
Test Voltage Between all Terminals & Enclosure	IEC 60947-5-1 / UL 508	2.5 kV
Over Voltage Category	IEC 60947-1	IV
Impluse Voltage Between I/P & O/P	IEC 60947-5-1	Level 4kV
Single Fault	IEC 61010-1	
Insulation Resistance	UL 508	>50kOhm
Leakage Current	UL 508	<3.5 mA

Environmental

Cold Heat	IEC 60068-2-1	
Dry heat	IEC 60068-2-2	
Vibration	IEC 60068-2-6	5g(10-50 Hz)
Repetitive Shock	IEC 60068-2-27	40 g, 6 ms
Non-repetitive Shock	IEC 60068-2-27	30 g, 15 ms

Note: As per IEC60947-2 (B.4.2.2) The minimum value of rated residual non operating current is 0.5 IΔn.



TEKNİK ÖZELLİKLER	ELR-30-M	ELR-30-A		
Kaçak Akım Rölesi Tipi	A Tipi			
BESLEME ÖZELLİKLERİ				
Besleme Gerilimi	220-415VAC / 220VDC -20% to +20%			
Güç Tüketimi (Maks.)	10VA			
LED Göstergesi	Güç AÇIK	Cihaz AÇIK (Yeşil LED)		
	EL / CT	Cihaz AÇIK(Kırmızı LED) Röle Açma / Yanıp Sönme (CT AÇIK)		
	Kaçak Akım / TST	Çubuk grafiğine göre %30(Yeşil), %45(Yeşil), %60(Sarı) ve %75(Kırmızı), Yanıp Sönme Testi / Sıfırlama Butonuna Basılı olduğunda		
Eşik değeri IΔn (A)	0.03 – 0.1 – 0.3 – 0.5 – 1 – 3 – 5 – 10 – 20 – 30			
Frekans	50-60Hz			
RÖLE O / P ÖZELLİKLERİ				
Kontakt Çıkışı	1 C/O + 1 NO; 5 A (Rezistif) @ 240 VAC / 30 VDC			
Kontakt Ayarı	1 C/O SPDT ve 1 NO SPST			
Kullanım Kategorisi (AC-15)	120V'da 3.0A & 240V'da 1.5A			
Kullanım Kategorisi (DC-13)	125V'da 0.22A & 250V'da 0.10A			
Beklenen Mekanik Ömür	1X10 ⁷			
Beklenen Elektriksel Ömür	1X10 ⁵			
Kontakt Malzemesi	Ag (Gümüş) Alaşımı			
RESET ÖZELLİKLERİ				
Reset	Manuel Reset	Otomatik Reset		
Otomatik Reset Sayısı	-	4		
Otomatik Reset Temizle	1 saatlik sabit güçten veya besleme kesintisinden sonra			
Test / Reset	Cihaz üzerinden ve uzaktan sıfırlama			
Δt Ayarları (s)	0.040 – 0.06 – 0.15 – 0.25 – 0.5 – 0.8 – 1 – 2.5 – 5 – 10			
Resetlemeyi Etkinleştir	CBTC ile birlikte IΔn setinin %50'sinin altında			
Resetleme Süresi	<1 sn			
Reset	IΔ1A'ya kadar "A" Doğru RMS ölçümü (IEC 60947-2 Annex M 'a uygun olarak) 30mA-30A "AC" Doğru RMS ölçümü(IEC 60947-2 Annex M'a uygun olarak)			
Ayar Doğruluğu	- 20% (CBCT doğruluğu dahil)			
Tekrarlama Doğruluğu	± 2%			
ÇEVRE KOŞULLARI				
Depolama Sıcaklığı	-20°C ... + 80°C			
Çalışma Sıcaklığı	-15°C ... + 60°C			
Bağıl Nemlilik	5 ... 95% Rh (Yoğuşma olmadan)			
Maksimum Çalışma Yüksekliği	2000 m			
Koruma Sınıfı	Klemensler için IP20, Dış Kutu için IP40			
Çalışma Pozisyonu	Hiç			
Kirlilik Derecesi	II			
DİĞER				
Montaj	DIN Raya			
Boyutlar(mm)	36 X 90 X 65			
Yaklaşık Ağırlık. (paketlenmemiş)	150g			
Sertifikalar				
A TİPİ VE AC AKIM İÇİN CBCT				
	Boyut (G x Y x D) mm	İç Çap	Faz Başına Maks. Akım	Darbeli DC akımı varsa IΔn ayar aralığı (A Tipi)
CBCT-70	37x133x109.3	70mm	160A	30mA - 3A
CBCT-92	37x155x132	92mm	200A	30mA - 30A
CBCT-120	37x176x153	120mm	250A	30mA - 30A
CBCT-210	37x282x250	210mm	400A	30mA - 30A
CBCT-R-350 DİKDÖRTGEN AKIM TRAFOSU				
Dönüş Oranı	1 : 1500			
Frekans	50-60Hz			
Kaçak Akım Aralığı	30mA... 30A			
Nominal İşletme Akımı	2500A'ye kadar			
Çalışma Sıcaklığı	-20°C...+65°C			
Depolama Sıcaklığı	-20°C...+85°C			
Boyutlar(mm)	350 x 150x 30mm			
Ağırlık(Kg)	3.7Kg			

ELR & CBCT TOPRAK KAÇAK AKIM RÖLESİ & TOROİD AKIM TRAFOSU SERİSİ

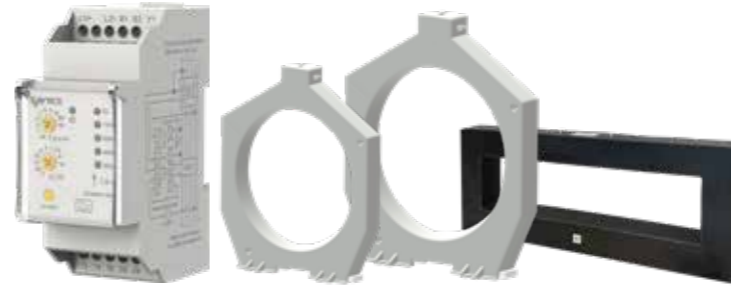

EWTES Hızlı Kurulum Talimatı

Açma Özellikleri

Standart IEC 60947-2 annex M", standart IEC 0947-2 annex M'deki B.4.2.4.1'deki tablo B.1'de zaman gecikmesiz tip için çalışma karakteristiğini gösterir. IΔn=30mA değerine sahip CBR'ler gecikmesiz tipte olacaktır. Açma süresi '0' saniye olarak ayarlanırsa, 5 IΔn & 10 IΔn için, açma süresi tüm mevcut aralıklar için <40 ms olacaktır.

Kaçak Akım	IΔn	2IΔn	5IΔn ¹	10IΔn ²
Maksimum Kesme Süresi	0.3	0.15	0.04	0.04
1) IΔn < 30 mA olan CBR'ler için 5IΔn'ye alternatif olarak 0,25A kullanılabilir.				
2) 0.25A 1.maddeye göre kullanılırsa 0.5A				

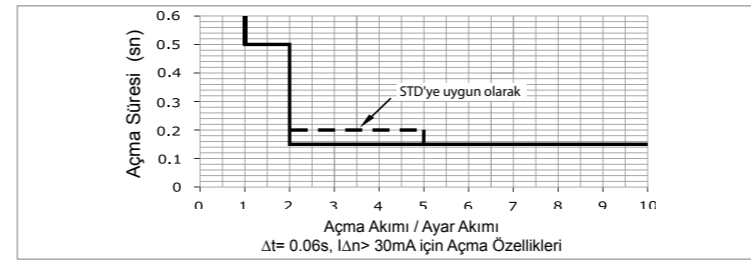

0,06 sn'lik çalıştırma süresini sınırlayan CBR'ler için çalışma özellikleri, IEC 60947-2 annex M standardı B.4.2.4.1'deki tablo B.2'de verilmiştir.

Kaçak Akım	IΔn	2IΔn	5IΔn ¹	10IΔn ²
Maksimum Kesme Süresi (sn)	0.5	0.2	0.15	0.15

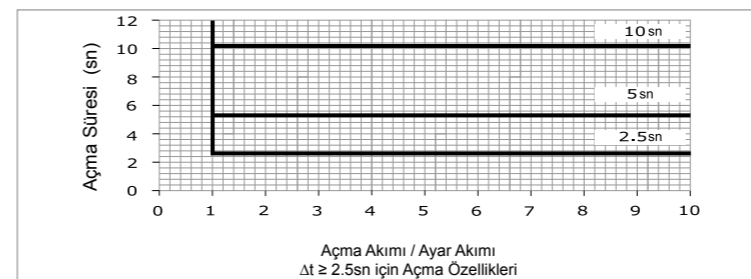
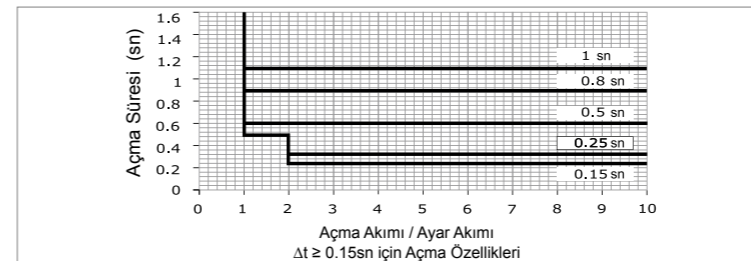
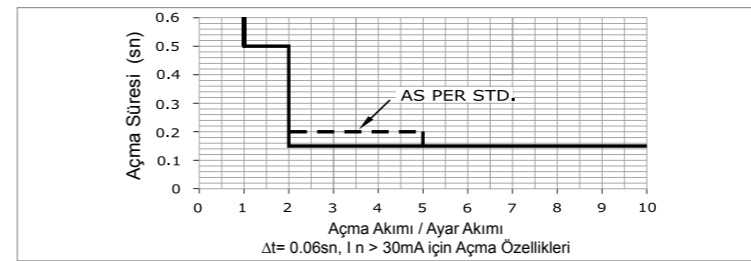

t ≥ 0.15s için Açma Özellikleri

EN 60947-2:2003 0,06sn'den daha yüksek bir çalıştırma dışı sınırlama süresine sahip CBR'ler için çalışma karakteristiği B.4.2.4.2' tarafından beyan edilmiştir. IΔn, 2 IΔn, 5IΔn ve 10 IΔn 'de maksimum kesme süreleri aşağıdaki tabloda gösterilmiştir.

Kaçak Akım Açma Ayarı	Maksimum Kesme Süresi (sn)			
	IΔn	2IΔn	5IΔn ¹	10IΔn ²
0.15 sn	0.5	0.25	0.25	0.25
0.25 sn	0.5	0.35	0.35	0.35
0.5 sn	0.6	0.6	0.6	0.6
0.8 sn	0.9	0.9	0.9	0.9
1 sn	1.1	1.1	1.1	1.1
2.5 sn	2.6	2.6	2.6	2.6
5 sn	5.1	5.1	5.1	5.1
10 sn	10.1	10.1	10.1	10.1

Özellikler

- Geniş kaçak akım ayarı aralığı
- Ayarlanabilir kaçak akım açma süresi
- Anlık açma (ayrıntılar için açma özelliklerine bakın)
- Cihazın düzgün çalışıp çalışmadığını kontrol etmek için "Test Özelliği"
- Cihaz üzerindeki reset anahtarını aracılığı ile "Manuel Reset Özelliği"
- Uzaktan reset özelliği
- 1C/O+1NO Röle Çıkışı
- Tüm hata durumları için LED göstergeleri
- Geniş yardımcı besleme voltaj aralığı
- DIN raya montaj
- Kolay kurulum
- Kompakt boyut

Öneriler

Açma akımı doğruluğunu sağlamak için tabloda belirtildiği gibi CBCT'lerin kullanılması önerilir.

⚠ Dikkat

- Her zaman bu kullanma talimatında belirtilen maddelere uyun.
- Kurulumdan önce, teknik özelliklerin amaçlanan uygulamayla uyumlu olduğundan emin olun.
- Kurulum yetenekli bir elektrik teknisyeni tarafından yapılmalıdır.
- Montaj sırasında aşırı titreşim olması durumunda uygun damperler sağlanmalıdır.
- Otomasyon ve kontrol cihazları, herhangi bir istem dışı çalışma riskine karşı korunacak şekilde kurulmalıdır.
- Cihaz ve ekipmanlar üzerinde çalışmadan önce gücü kesin.

Klemens Detayları

Ø3.5 mm	0.54 N.m (4.7Lb.in) Klemens vidası - M2.6
AWG	1 x 0.2...3.3 mm ² Tek Damarlı Kablo
	1 x 24 to 12

Yalnızca 60/75°C Cu(Bakır) Teli kullanın

Notlar

- Ürünün yenilenmesi düzenli bir süreç olduğundan, tüm özelliklerini önceden haber vermeksizin değiştirmeye hakkımızı saklı tutuyoruz.
- Cihazın fabrika ayarları 30mA açma ve anlık gecikme olarak ayarlanmıştır. Bu ayarlar kurulumun gerektirdiği şekilde ayarlanabilir. Kullanıcının şeffaf pencereyi emniyete almasına ve dolayısıyla ayarların gereksiz şekilde değiştirilmesini engellemesine olanak tanıyan bir conta birlikte verilmektedir.
- Yönetmeliklere uymak amacıyla, cihazın doğru çalışmasını sağlamak amacıyla periyodik olarak test edilmesi önerilir.
- Aşırı harmonik olması durumunda, kablo kapasitesinin sunduğu düşük empedans nedeniyle güç iletim kablolarında daha fazla kaçak olması durumunda, IΔn ayarının daha yüksek seviyede tutulması gerekir.

